

Inspect and Replace Steering Components

Meets NATEF Task: (A4-B-16) Inspect and replace pitman arm, relay (centerlink/intermediate) rod, idler arm and mountings, and steering linkage damper. (P-2)

Name _____ Date _____ Time on Task _____

Make/Model/Year _____ VIN _____ Evaluation: 4 3 2 1

_____ 1. Check the service information for the specified testing and inspection procedures and specifications.

A. Specified testing procedures: _____

B. Specifications: _____

_____ 2. Check the steering components listed and note their condition.

Idler arm: _____

Pitman arm: _____

Centerlink: _____

Steering linkage damper: _____

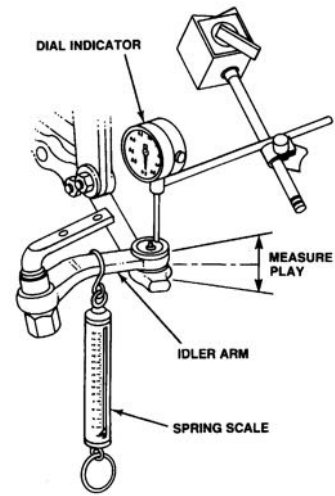

_____ 3. State the specified replacement procedure and list any specific tools needed.

Idler arm: Procedure _____

Tools _____

Pitman arm: Procedure _____

Tools _____

Centerlink: Procedure _____

Tools _____

Steering linkage damper: Procedure _____

Tools _____