

Use Wiring Diagrams to Diagnose a Circuit

Meets NATEF Task: (A6-A-7) Use wiring diagrams during diagnosis of electrical circuit problems. (P-1)

Name _____ Date _____ Time on Task _____

Make/Model/Year _____ VIN _____ Evaluation: 4 3 2 1

- _____ 1. Check service information regarding the horn circuit and determine where the fault has to be located if the horn relay “clicks” when the horn button is pressed, but the horn(s) does not operate.

- _____ 2. Check service information regarding the brake light circuit and determine where the fault(s) could be if the brake lights at the rear of the vehicle do not work, yet the third (high-mounted) stop light works OK.

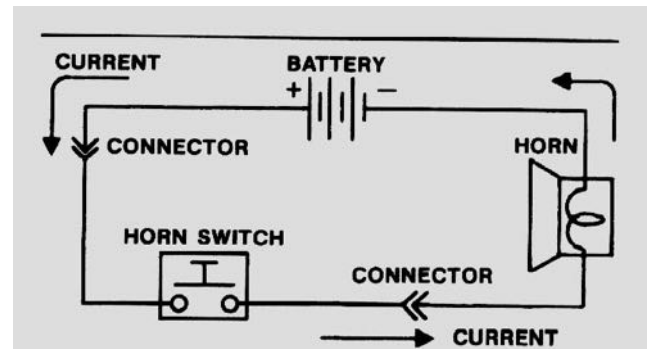

- _____ 3. Check service information regarding the blower motor circuit and determine where the fault(s) could be if only the high-speed blower works (none of the lower speeds work).
