

Rear Leaf Springs

Meets NATEF Task: (A4-C-12) Remove, inspect, and install leaf springs, leaf spring insulators (silencers), shackles, brackets, bushings, and mounts. (P-1)

Name _____ Date _____ Time on Task _____

Make/Model/Year _____ VIN _____ Evaluation: 4 3 2 1

_____ 1. Check the service information for the specified procedure for the removal and reinstallation of rear leaf springs.

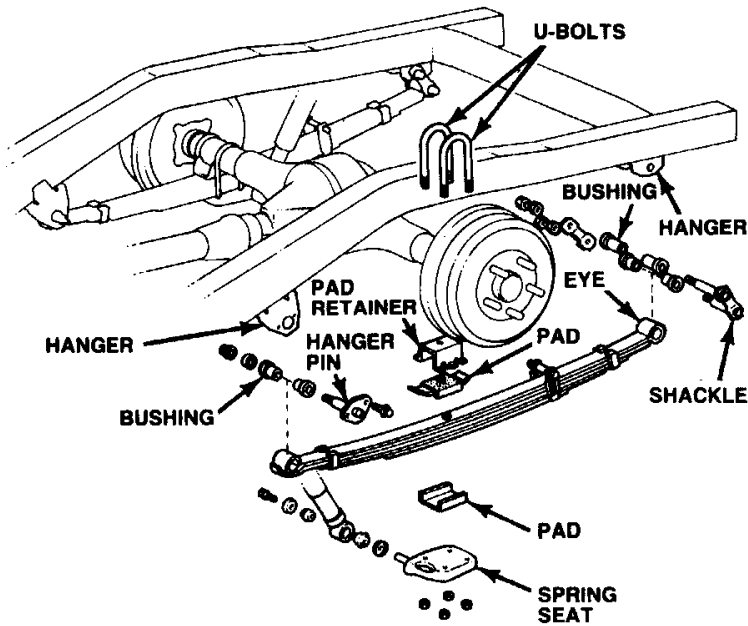

_____ 2. List the tools and equipment needed. _____

_____ 3. Show the instructor the removed rear leaf spring(s). **Instructor's OK** _____

_____ 4. List the tightening torque specifications for the affected fasteners. _____
